

Article number: 12307200060110

Description: KLEE-coil 307 200 060.110
M6 Hardened/zinc-plated steel with hexagon

Measures

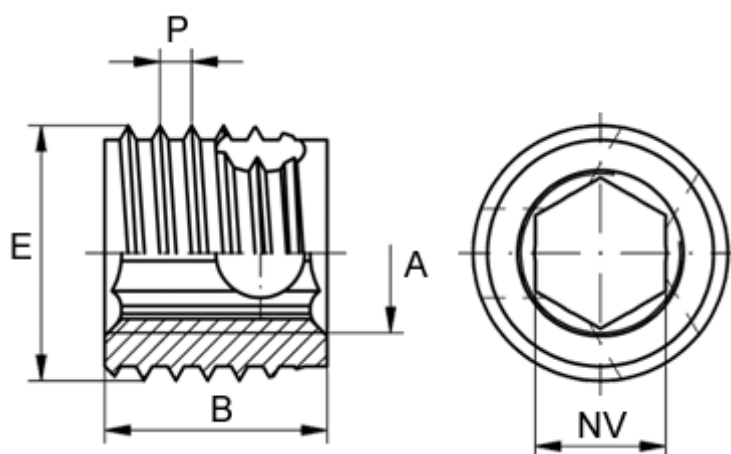

Female thread A	= M6
Length B	= 8
Male thread E	= 10
Min hole depth blind hole	= 11
Min material thickness	= 8
sw	= -
Thread pitch P	= 1.25
Type	= 307 200 060 ...